

# International IOR Rectifier

## MUR3020WT

### Ultrafast Rectifier

#### Features

- Ultrafast Recovery Time
- Low Forward Voltage Drop
- Low Leakage Current
- 175°C Operating Junction Temperature

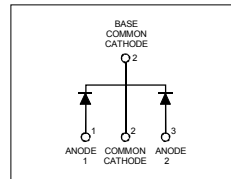

$$t_{rr} = 35\text{ns}$$

$$I_{F(AV)} = 30\text{Amp}$$

$$V_R = 200\text{V}$$

#### Description/ Applications

International Rectifier's MUR...series are the state of the art Ultra fast recovery rectifiers specifically designed with optimized performance of forward voltage drop and ultra fast recovery time. The planar structure and the platinum doped life time control, guarantee the best overall performance, ruggedness and reliability characteristics.

These devices are intended for use in the output rectification stage of SMPS, UPS, DC-DC converters as well as free-wheeling diode in low voltage inverters and chopper motor drives.

Their extremely optimized stored charge and low recovery current minimize the switching losses and reduce over dissipation in the switching element and snubbers.

#### Package Outline

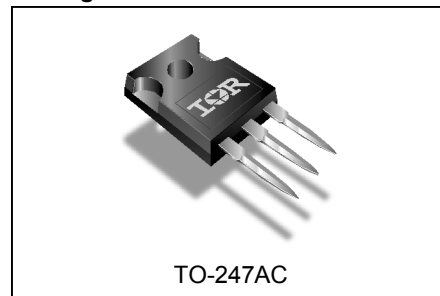

#### Absolute Maximum Ratings

Parameters		Max	Units
$V_{RRM}$	Peak Repetitive Peak Reverse Voltage	200	V
$I_{F(AV)}$	Average Rectified Forward Current Per Leg	15	A
	Total Device, (Rated $V_R$ ), $T_C = 150^\circ\text{C}$ Total Device	30	
$I_{FSM}$	Non Repetitive Peak Surge Current Per Leg	200	
$I_{FM}$	Peak Repetitive Forward Current Per Leg (Rated $V_R$ , Square wave, 20 KHz), $T_C = 150^\circ\text{C}$	30	
$T_J, T_{STG}$	Operating Junction and Storage Temperatures	- 65 to 175	$^\circ\text{C}$

**Electrical Characteristics @ T<sub>J</sub> = 25°C (unless otherwise specified)**

Parameters	Min	Typ	Max	Units	Test Conditions
V <sub>BR</sub> , V <sub>r</sub> Breakdown Voltage, Blocking Voltage	200	-	-	V	I <sub>R</sub> = 100μA
V <sub>F</sub> Forward Voltage	-	-	1.05	V	I <sub>F</sub> = 15A
	-	-	0.85	V	I <sub>F</sub> = 15A, T <sub>J</sub> = 150°C
I <sub>R</sub> Reverse Leakage Current	-	-	10	μA	V <sub>R</sub> = V <sub>R</sub> Rated
	-	-	500	μA	T <sub>J</sub> = 150°C, V <sub>R</sub> = V <sub>R</sub> Rated
C <sub>T</sub> Junction Capacitance	-	55	-	pF	V <sub>R</sub> = 200V
L <sub>S</sub> Series Inductance	-	12	-	nH	Measured lead to lead 5mm from package body

**Dynamic Recovery Characteristics @ T<sub>J</sub> = 25°C (unless otherwise specified)**

Parameters	Min	Typ	Max	Units	Test Conditions
t <sub>rr</sub> Reverse Recovery Time	-	-	35	ns	I <sub>F</sub> = 1.0A, di <sub>F</sub> /dt = 50A/μs, V <sub>R</sub> = 30V
	-	22	-		T <sub>J</sub> = 25°C
	-	39	-		T <sub>J</sub> = 125°C
I <sub>R</sub> RRM Peak Recovery Current	-	1.6	-	A	T <sub>J</sub> = 25°C
	-	4.1	-		T <sub>J</sub> = 125°C
Q <sub>rr</sub> Reverse Recovery Charge	-	19	-	nC	T <sub>J</sub> = 25°C
	-	90	-		T <sub>J</sub> = 125°C

**Thermal - Mechanical Characteristics**

Parameters	Min	Typ	Max	Units
T <sub>J</sub> Max. Junction Temperature Range	-	-	-65 to 175	°C
T <sub>Stg</sub> Max. Storage Temperature Range	-	-	-65 to 175	
R <sub>thJC</sub> Thermal Resistance, Junction to Case			1.5	°C/W
R <sub>thJA</sub> <sup>①</sup> Thermal Resistance, Junction to Ambient			40	
R <sub>thCS</sub> <sup>②</sup> Thermal Resistance, Case to Heatsink		0.5	-	
Wt Weight	-	6.0	-	g
	-	0.21	-	(oz)
Mounting Torque	6.0	-	12	Kg-cm
	5.0	-	10	lbf.in

① Typical Socket Mount

② Mounting Surface, Flat, Smooth and Greased

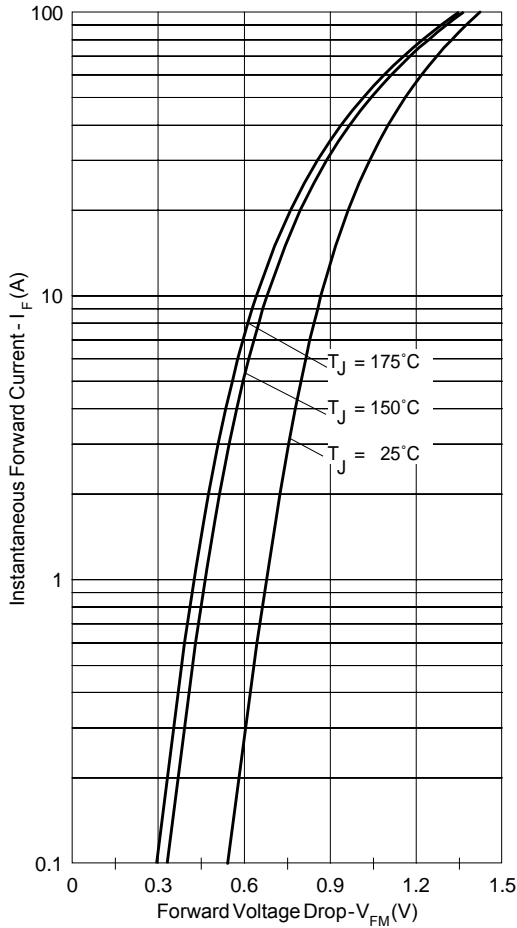

Fig. 1 - Typical Forward Voltage Drop Characteristics

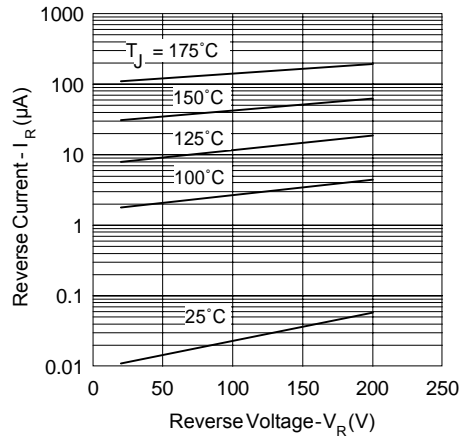

Fig. 2 - Typical Values Of Reverse Current Vs. Reverse Voltage

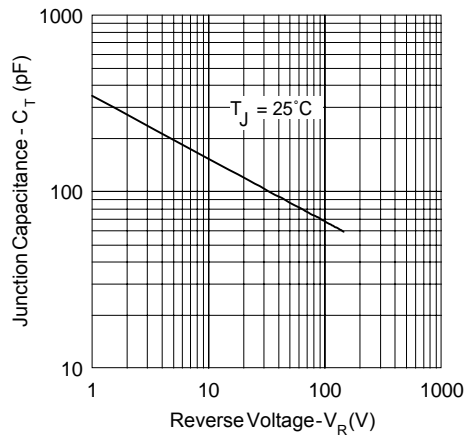

Fig. 3 - Typical Junction Capacitance Vs. Reverse Voltage

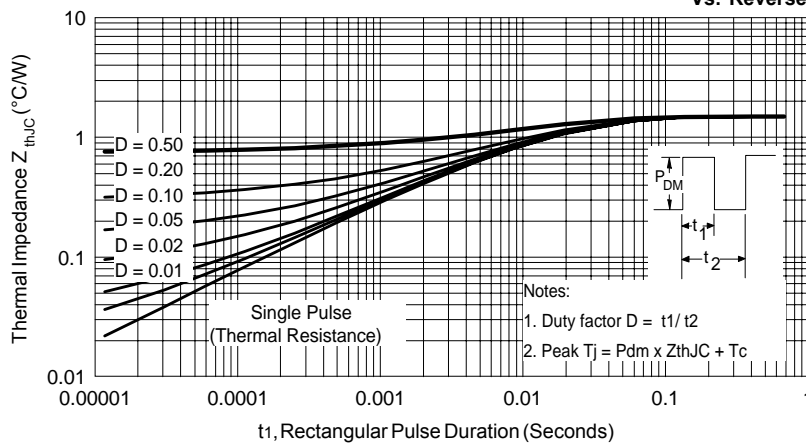

Fig. 4 - Max. Thermal Impedance  $Z_{thJC}$  Characteristics

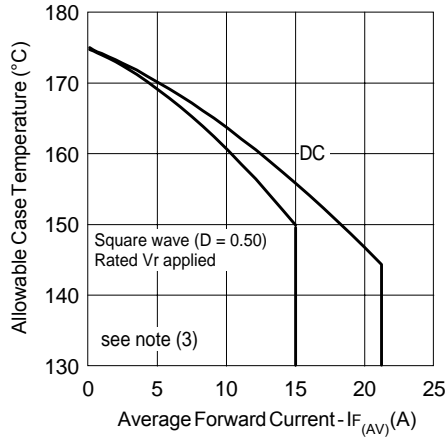

Fig. 5 - Max. Allowable Case Temperature Vs. Average Forward Current

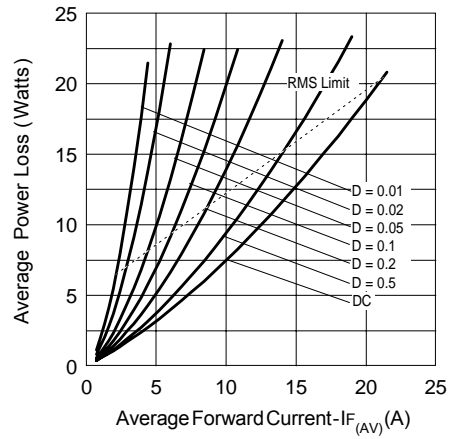

Fig. 6 - Forward Power Loss Characteristics

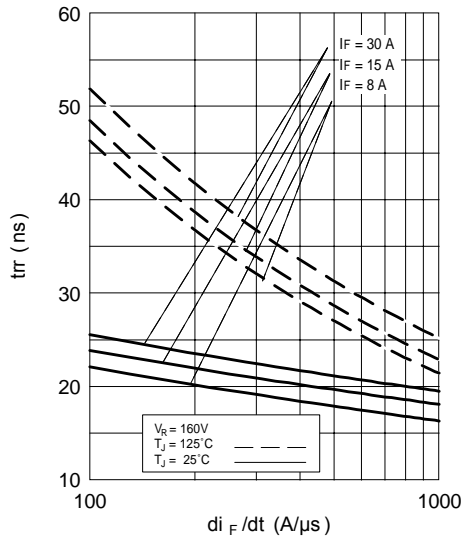

Fig. 7 - Typical Reverse Recovery vs.  $di_F/dt$

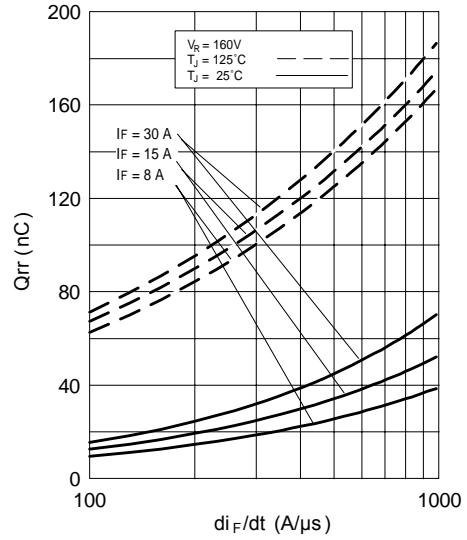
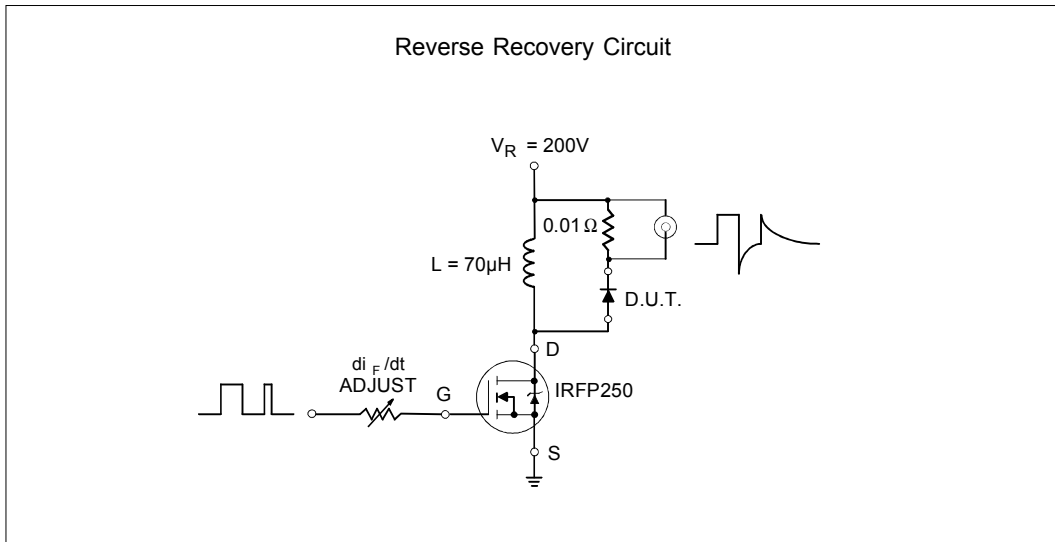
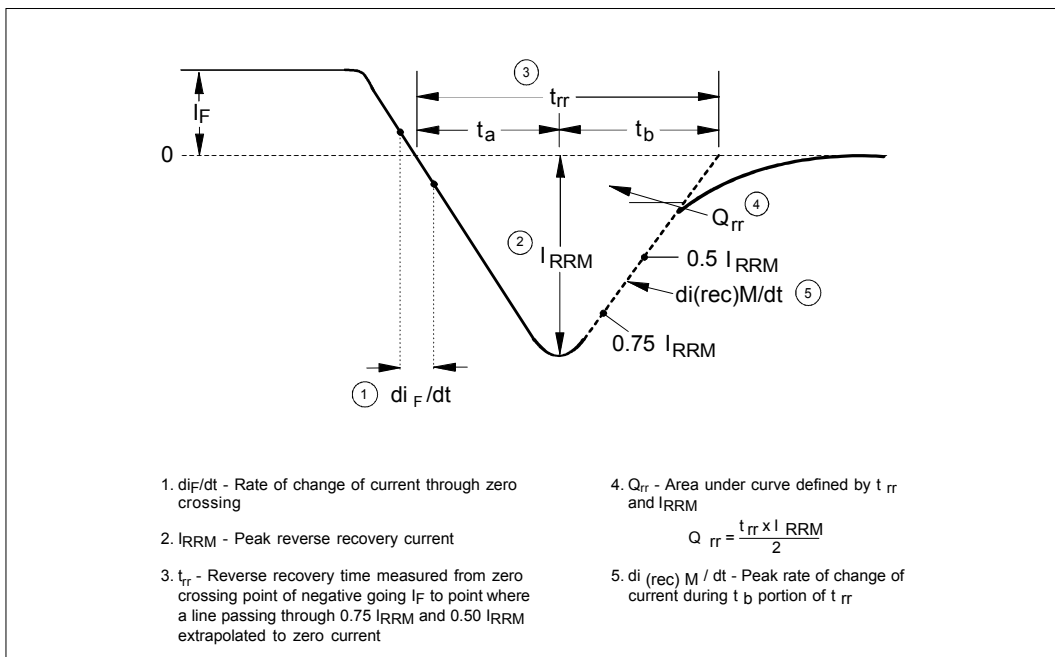

Fig. 8 - Typical Stored Charge vs.  $di_F/dt$

(3) Formula used:  $T_C = T_J - (Pd + Pd_{REV}) \times R_{thJC}$ ;  
 $Pd = \text{Forward Power Loss} = I_{F(AV)} \times V_{FM} @ (I_{F(AV)} / D)$  (see Fig. 6);  
 $Pd_{REV} = \text{Inverse Power Loss} = V_{R1} \times I_R (1 - D); I_R @ V_{R1} = \text{rated } V_R$

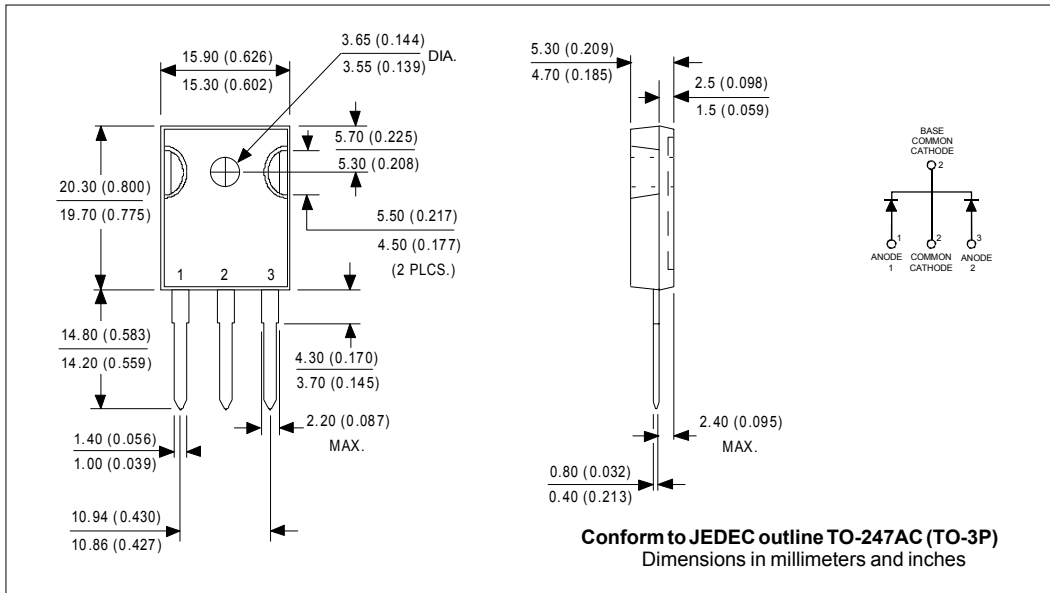

**Fig. 9- Reverse Recovery Parameter Test Circuit**



**Fig. 10 - Reverse Recovery Waveform and Definitions**

Outline Table



Ordering Information Table

Device Code			
<b>MUR</b>	<b>30</b>	<b>20</b>	<b>WT</b>
①	②	③	④
<b>1</b>	-	Ultrafast MUR Series (TO-247AC)	
<b>2</b>	-	Current Rating (30 = 30A)	
<b>3</b>	-	Voltage Rating (20 = 200V)	
<b>4</b>	-	WT = Center Tap (Dual) TO-247	

Data and specifications subject to change without notice.  
This product has been designed and qualified for Industrial Level.  
Qualification Standards can be found on IR's Web site.

International  
**IOR** Rectifier

**IR WORLD HEADQUARTERS:** 233 Kansas St., El Segundo, California 90245, USA Tel: (310) 252-7105  
TAC Fax: (310) 252-7309  
Visit us at [www.irf.com](http://www.irf.com) for sales contact information. 05/01